



6+
30564



6345932

WIN

GO TO WWW.LEGO.COM/RB2021 TO
FILL OUT A SHORT **SURVEY** ON THIS
PRODUCT FOR A CHANCE TO WIN
A COOL LEGO® SET.

Terms & Conditions apply

LEGO.com/RB2021



GAGNE
Rendez-vous au www.LEGO.com/RB2021
pour remplir un court questionnaire sur ce
produit et courir la chance de gagner un
fantastique ensemble LEGO®.
Voir Conditions Générales

GANA
Visita www.LEGO.com/RB2021
y responde una breve encuesta sobre este producto.
¡Puedes ganar un fantástico set LEGO®!
Términos y Condiciones aplicables

1

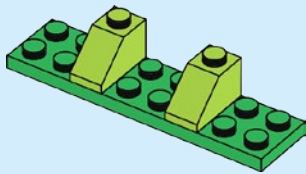

3

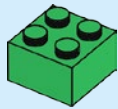

7

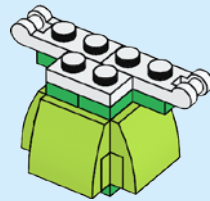

11

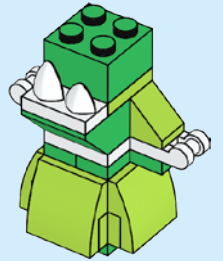

1

2

3

4

2

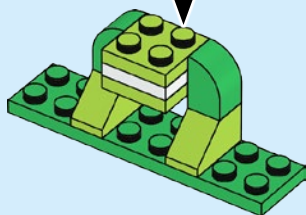

4

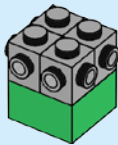

8

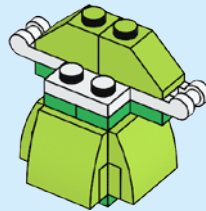

12

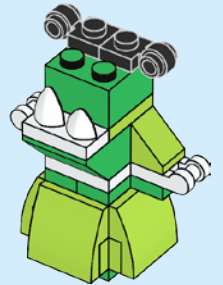

5

3x

5

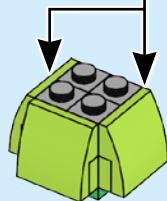

9

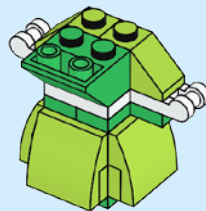

13

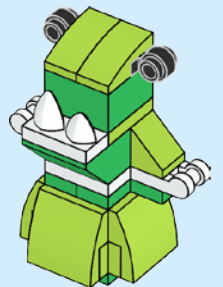

10

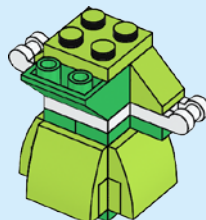

14

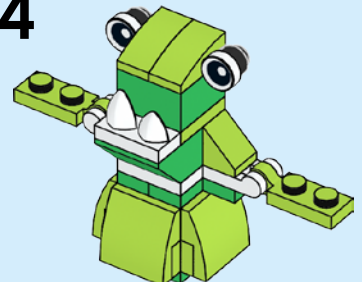

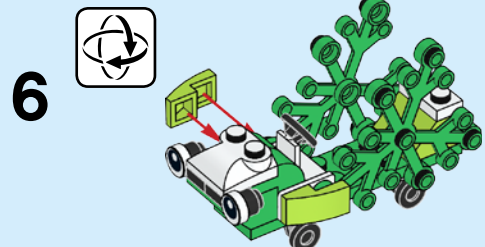
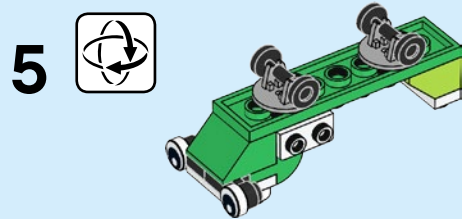
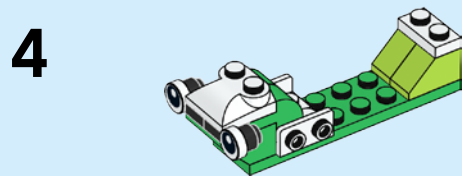
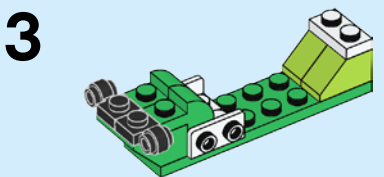
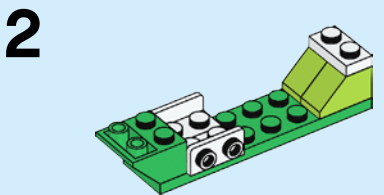
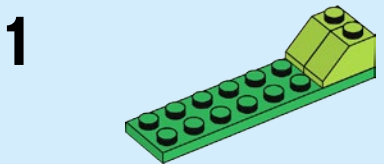
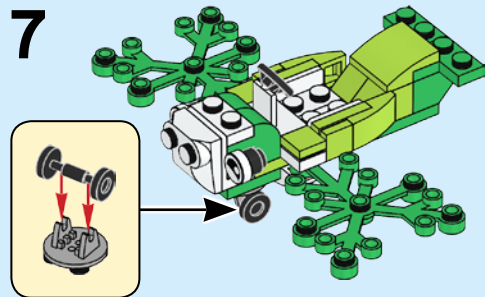
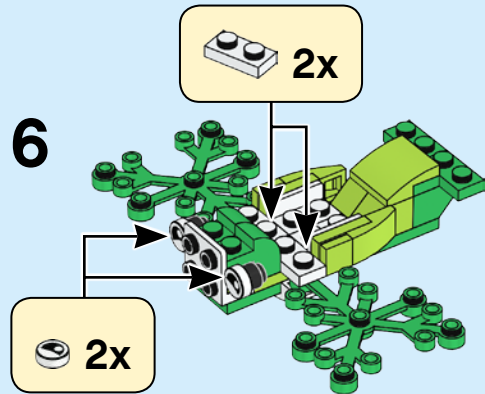
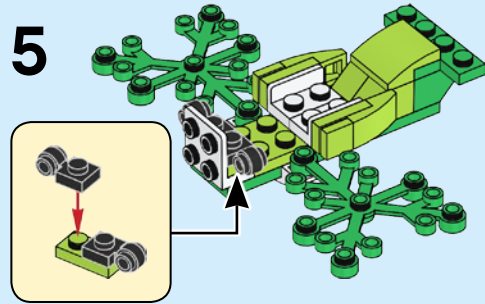
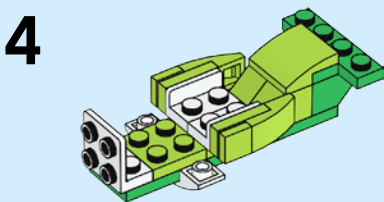
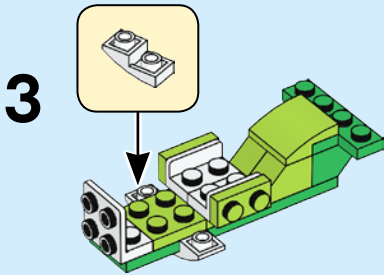
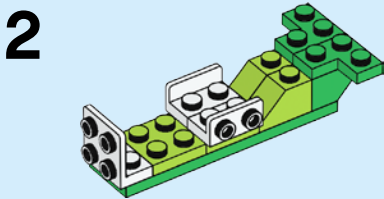
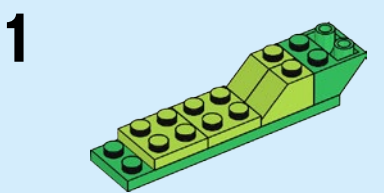
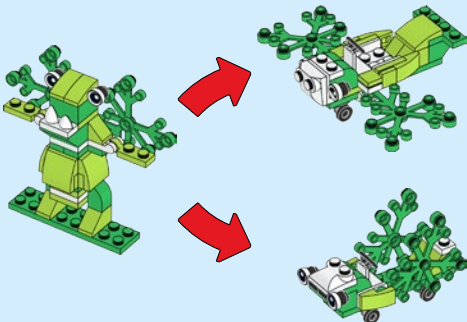
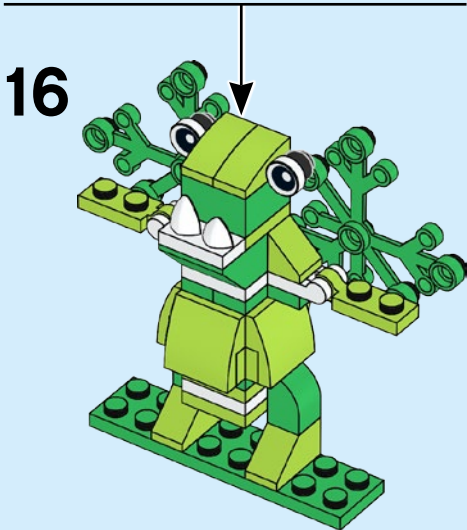
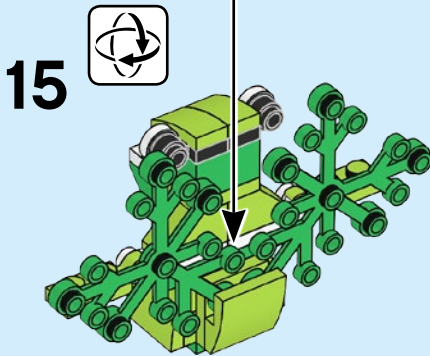
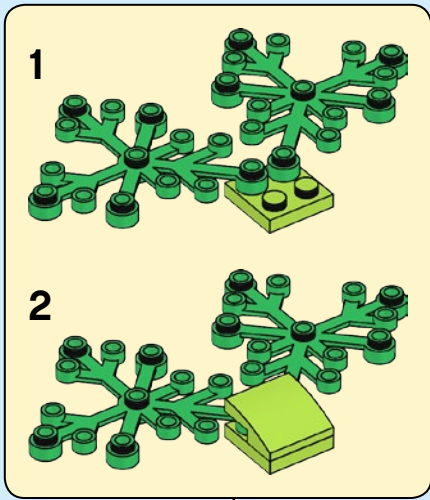

- | | | | | | | | | | | | | | | |
|---------------|---------------|---------------|---------------|---------------|---------------|---------------|---------------|---------------|---------------|---------------|---------------|---------------|--------------|---------------|
| 3x
302301 | 2x
6172927 | 2x
6284605 | 2x
6284599 | 2x
6070698 | 2x
6281993 | 2x
6152344 | 2x
6069006 | 2x
6138122 | 4x
6138661 | 4x
4537251 | 2x
4157120 | 2x
6266968 | 1x
303428 | 2x
6100223 |
| 2x
4515364 | 1x
6046384 | 1x
9551 | 1x
6097637 | 1x
4494474 | 2x
249626 | 4x
6267495 | 3x
4164037 | 4x
4537925 | 4x
4537937 | 2x
300328 | 1x
4142717 | | | |